

Analog vs. Next-Generation Digital Fronthaul: How to Minimize Optical Bandwidth Utilization

Malte Hinrichs, Luz Fernandez del Rosal, Christoph Kottke, Volker Jungnickel

Photonic Networks and Systems
Fraunhofer Heinrich Hertz Institute
Berlin, Germany

Abstract—In this paper we investigate two promising approaches to reduce the optical bandwidth utilization in the mobile fronthaul of next-generation cloud radio access networks. We analyze and compare the performance of an analog radio-over-fiber and a new digital fronthaul in a chromatic dispersion-limited scenario. The former uses several analog channels, generated by up- and down-converting of baseband signals, and the latter utilizes simple OOK NRZ for the transmission to the remote radio head. Both principles are applied to a custom millimeter-wave system, consisting of several analog channels with baseband bandwidths as expected for 5G. The performance of both concepts at transmission rates of up to 100 Gb/s and 100 km of fiber is evaluated. We will show that both approaches are suitable for transmission distances typical for fronthaul and discuss their advantages and disadvantages. Furthermore, an optimized bandwidth concept for the analog radio-over-fiber system is presented, which enables transmission distances on the scale of metro networks.

Keywords—analog fronthaul, next-generation digital fronthaul, intermediate frequencies-over-fiber (IFoF), next-generation mobile network (5G), millimeter wave (mm-wave)

I. INTRODUCTION

The evolution towards a centralized radio access network (C-RAN), where multiple basis band units (BBU) are co-located to jointly serve multiple remote radio heads (RRH), provides many advantages such as cost reduction, the ability to implement coordinated wireless techniques, and to virtualize network functionalities to perform dynamic load balancing [1]. All this yields a more efficient use of network resources. Nevertheless, it also imposes more stringent requirements on the transport network connecting the BBU pool to the RRHs, also known as mobile fronthaul (MFH). The increasing demand for higher data rates in the fronthaul will be driven by a massive deployment of small cells, the installation of numerous antennas to implement massive multiple input multiple output (m-MIMO), and the use of wider wireless bandwidths, through carrier aggregation or the use of higher frequency bands such as millimeter waves (mm-wave) [2, 3]. In such a 5G scenario, current fronthaul transmission protocols, such as the widespread common public radio interface (CPRI), open base station standard initiative (OBSAI), or open radio interface (ORI), become impractical. In a CPRI-based MFH, as shown in Fig. 1 (a), digitized in-phase (I) and quadrature (Q) samples are transmitted over the fronthaul. At the RRH, the

digital-to-analog converter (DAC) converts the digital samples to an analog signal that is further processed by the radio frequency (RF) components. The data rate required on the fronthaul for a 20 MHz LTE signal with a sample resolution of 16 bits for I and Q would be 983.04 Mbit/s. Extrapolating to a 5G scenario with a wireless signal sampled at 1 GS/s, the implementation of m-MIMO with 128 antennas and a resolution of 16 bits for I and Q would result in a fronthaul data rate of 4,096 Gb/s [4].

Recently, a lot of effort has been spent to investigate how to cope with the challenging data rate requirements and reduce the optical bandwidth in the mobile fronthaul of next generation mobile networks. One approach consists of applying compression on the fronthaul data. There are different methods enabling compression factors up to 50%, but at the expense of some data degradation and extra processing delay [5].

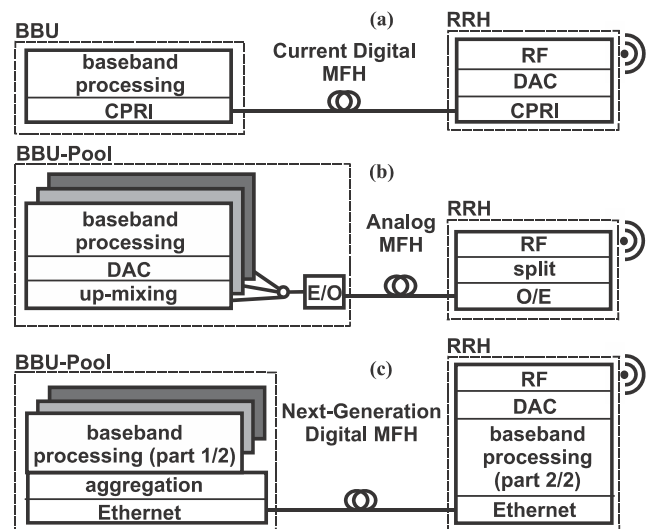

Fig. 1. Architecture of mobile fronthaul (MFH) implementations: (a) current MFH over CPRI, (b) analog IF-over-fiber, (c) next-generation digital MFH over Ethernet.

A more promising approach is based on the transmission of analog wireless signals over the fronthaul instead of digitized waveforms, as shown in Fig. 1 (b). Several wireless signals are up-converted to different intermediate frequencies (IF) and multiplexed electrically to be jointly transmitted over the same optical fiber. This approach has been widely investigated [6-9] and successful transmissions of 30 x 20 MHz Long Term

Evolution (LTE) Advanced signals [6] or 96 x 20 MHz LTE signals [7] have been demonstrated over 20 km of optical fiber. For the resulting RF bandwidths, mostly below 3 GHz, and fronthaul distances up to 20 km, dispersion-induced fading is not an issue but other impairments such as non-linear intermodulation distortion [6] are dominant. However, much greater aggregated wireless bandwidths are expected for 5G, and chromatic dispersion (CD) is one limiting factor for such analog IF over fiber (IFoF) systems.

Another more disruptive approach to reduce the optical bandwidth in the fronthaul is based on a redistribution of the functionalities between the BBU and the RRH [4, 10-12]. In current 4G systems, all signal processing is performed at the BBU and digitized waveforms are transmitted to the RRH. In the RRH, DAC and ADC are located together with all analog RF functionalities. Shifting part of the signal processing from the BBU to the RRH can enable the transmission of higher layer user data instead of digital baseband samples, thus reducing the required data rate in the fronthaul. Moreover, the resulting data rate depends on the actual traffic demand, making statistical multiplexing gains possible. This principle is shown in Fig. 1 (c). As analyzed in [10] for LTE, setting the split e.g. between physical and medium access and control (MAC) layer would require up to 33% of the original fronthaul data rate in a 100% loaded network and up to 18% in a 50% loaded network. Additionally, as investigated in the European project iCIRRUS [4, 13, 14] and by other groups [11], the use of Ethernet as a transport protocol together with a modified functional split can achieve an even more efficient use of network resources exploiting the advantages associated to Ethernet.

With the ongoing deployment of wavelength division multiplex (WDM) systems in optical access networks, the influence of CD is one of the main challenges when it comes to higher transmission rates and lengths. Especially at wavelengths around 1550 nm, which offers the lowest attenuation and the application of widely available hardware, the influence of CD must be taken into account for the determination of the optimal transmission approach. This paper investigates the influence of CD at 1550 nm for the CPRI based digital MFH, the analog IFoF MFH, and the next generation digital MFH in a 5G scenario as shown in Fig. 1(a-c). To give an adequate impression of the behavior at different data rates, the performance for 10, 25, 40, and 100 Gb/s data rate is evaluated. We also present a spectrally optimized analog IFoF concept, which enables transmission distances up to 100 km. Please note that other transmission impairments like fiber nonlinearities or properties of real-world components can have a severe impact on the proposed systems. However, for this paper the focus is on chromatic dispersion.

The rest of the paper is organized as follows: section II describes the reference system used to simulate all solutions; section III describes the analog IFoF system setup and presents the simulation results; section IV focuses on the next-generation digital MFH simulation setup and discusses the simulation results; a comparison between both systems follows in section V, and, finally, conclusions are drawn in section VI.

II. MILLIMETER WAVE TRANSMISSION SYSTEM

The system taken as reference for the implementation of the two MFH solutions described in section I is described in detail in [15, 16]. The bidirectional system was originally designed for the transmission of mm-wave signals over fiber and consists of two identical channels in each direction that transport an aggregated gross data rate of 5 Gb/s. The modulation format is $\pi/4$ -shift differential quadrature phase shift keying ($\pi/4$ -SDQPSK) for enhanced robustness and reduced peak-to-average power ratio (PAPR) [17].

The system has been completely modeled in Matlab and implemented in a real-time Field Programmable Gate Array (FPGA)-platform [15, 16]. The main digital signal processing functions are shown in Fig. 2. At the transmitter, the data stream is first encoded by a forward error correction (FEC) block using the Reed-Solomon algorithm and then mapped to complex symbols by the $\pi/4$ -SDQPSK mapper. After the insertion of a periodic training sequence (TS) for data-aided processing at the receiver, the signal is pulse shaped with a root-raised cosine (RRC) filter and passed to the DAC. The receiver performs the analog to digital conversion, frame synchronization, correction of IQ-imbalance introduced by electrical IQ-mixers at the transmitter and the receiver, carrier frequency offset (CFO) compensation, and channel estimation and equalization. Afterwards the signal is $\pi/4$ -SDQPSK demodulated and FEC decoded.

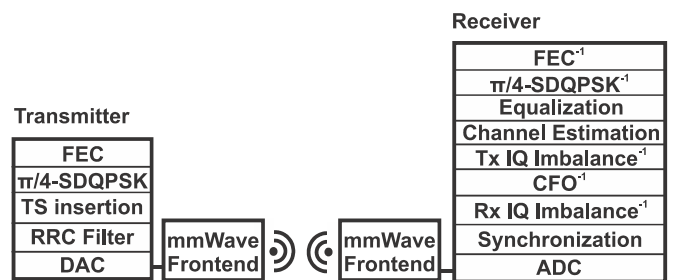

Fig. 2. Reference system signal processing for millimeter wave transmission.

The system consists of 4 DACs, each one for every complex channel (I and Q). The DACs work at 2.5 GS/s and have a resolution of 14 bits, which results in a data rate of 140 Gb/s for the transport of IQ samples over a CPRI-based fronthaul. This is much larger than the actual gross data rate of 5 Gb/s and illustrates once again how critical a fronthaul bandwidth optimization becomes for mm-wave signals. The analog outputs of the system have a baseband bandwidth of approximately 1 GHz similar to the envisioned bandwidths for 5G. Moreover, and since the proposed MFH transmission systems are waveform agnostic, an analysis and comparison between them can be made based on the described mm-wave system.

III. ANALOG IF-OVER-FIBER

To investigate the performance of the downlink of an analog IFoF fronthaul at different target data rates, we adapted the above system in a simulation environment. The simulations focus on the impact of CD on the system performance,

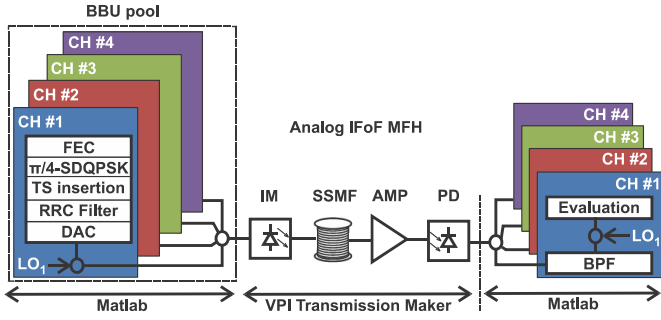

Fig. 3. Simulation setup for analog IF over fiber mobil fronthaul in case of 4 analog channels.

while other impairments, such as mixer IQ-imbalance or CFO, have not been considered. A more detailed investigation of these, based on experiments with real time transmission, can be found in [16].

A. Simulation Setup

In a first step only the 10 Gb/s scenario is evaluated. For the transmission of an aggregate gross data rate of 10 Gb/s, 4 channels, transmitting at 2.5 Gb/s each, were simulated. Fig. 3 shows the simulation setup. The BBU functions for the downlink were realized in Matlab with the complete transmitter signal processing described in the previous section, namely FEC encoder, $\pi/4$ -SDQPSK modulator, training sequence insertion and pulse shaping. For each channel a single radio frame containing 63 FEC blocks (128520 bits after FEC coding) was generated and transmitted. The baseband signals of the 4 channels were up-converted to different IFs by different local oscillators (LO). The channels were spaced at 2.5 GHz, resulting in an aggregated bandwidth of 10 GHz as shown in Fig. 4 (a). The LO frequencies were located at 1.25, 3.75, 6.25, and 8.75 GHz for channel 1, 2, 3, and 4 respectively. The roll-off factor of the RRC filter was set to 0.5 for every channel.

The optical fronthaul link applied a simple intensity modulation and direct detection (IM/DD) scheme and was simulated in the VPI Transmission Maker software. A continuous wave was generated in a laser at a wavelength $\lambda_c = 1552.5$ nm and externally modulated. A standard single mode fiber (SSMF) with a dispersion parameter of 16 ps/(nm km) was used for the fiber link. The optical signal was detected in a PIN photodiode. The transmitted optical power was set to 6 dBm, which is low enough to rule out penalties due to fiber nonlinearities. The received power was set to 0 dBm. At the receiver, a bandpass filter with 1.67 GHz bandwidth centered at the LO frequency was applied for each channel to suppress the neighboring channels. Then the signal was down converted to baseband and further processed in the evaluation block, which implements the receiver functions of the reference system and calculates the error vector magnitude (EVM).

B. Simulation Results

Fig. 4 (b) shows the EVM for the 4 channels over fiber length: most notably, a large peak in the EVM occurs on channel 4 at around 50 km. This effect is due to dispersion

induced fading, which is caused by the sidebands of the intensity-modulated optical signal experiencing different phase shifts due to CD. In a DD system, both optical sidebands ideally interfere constructively. Here, due to the differential phase shift between them after propagation along the fiber, a fading occurs that eventually leads to complete extinction of the signal. The magnitude of this fading can be estimated using (1) [18]:

$$P_{sig} \propto \cos^2\left(\frac{\pi L D}{c} \lambda_c^2 f_{sig}^2\right) \quad (1)$$

P_{sig} is the received signal power, L the fiber length, D the dispersion parameter, λ_c the optical carrier wavelength, and f_{sig} the signal carrier frequency. Equation 1 shows that the received signal power varies periodically with fiber length, and is eliminated where the argument of the \cos^2 function is a multiple of $\pi/2$, which occurs first at the length given by (2):

$$L_1 = \frac{c}{2D\lambda_c^2 f_{sig}^2} \quad (2)$$

L_1 is inversely proportional to the squared carrier frequency f_{sig} . This becomes the main limiting factor for the analog IFoF fronthaul at aggregated bandwidths above 10 GHz when covering typical fronthaul distances of up to 20-40 km. Here, L_1 is 50.77 km for channel 4 ($f_{sig} = 8.75$ GHz) and 99.5 km for channel 3 ($f_{sig} = 6.25$ GHz). The EVM of all channels remains below 10% for distances up to 37 km, which is below the limit of 17.5% that the 3GPP standard requires for QPSK in LTE [19].

In order to reduce the penalty of the fronthaul and leave as much margin as possible for the wireless link and other impairments not considered yet, a bandwidth optimization process was performed. The optimization included following parameters: roll-off factor of the RRC filters, channel spacing, and bandwidth of the BPF filters at the receiver. With the target of minimizing the impact on the EVM compared to the initial configuration, the process yielded a channel spacing of 1.5 GHz, resulting in an aggregated bandwidth of 6 GHz as shown in Fig. 5. The new LO frequencies were set to 0.75, 2.25, 3.75, and 5.25 GHz for channel 1, 2, 3, and 4 respectively. The roll-off factor was set to 0.25 and the receiver band-pass filter's (BPF) 3 dB frequency to 1.4 GHz.

Fig. 5 shows the EVM over fiber length for the optimized configuration. A small penalty in EVM can be observed in the

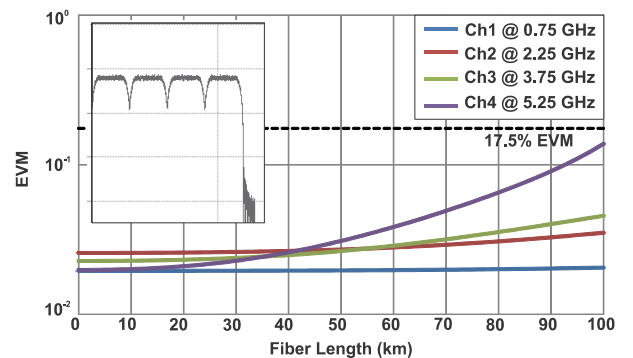

Fig. 4. EVM of 4 analog channels over fiber length for a channel spacing of 1.5 GHz. Inset shows the spectrum at the Tx.

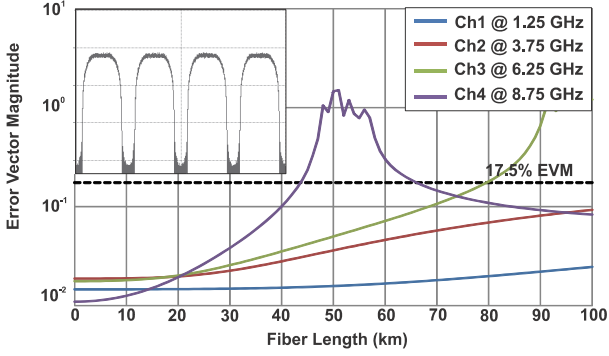

Fig. 5. EVM of 4 analog channels over fiber length for a channel spacing of 2.5 GHz. Inset shows spectrum at the Tx.

back-to-back (btb) configuration compared to the non-optimized case. This can be attributed to the increase peak-to-average power ratio (PAPR) of the signal. At the same time, the performance for large distances improves notably. Only channel 4 exceeds 10% EVM at all, and only at 94 km distance, while none of the channels exceeds an EVM of 2.5% at 40 km which leaves a large margin for the wireless transmission, that could also use higher-order modulation formats at this error level.

For the higher data rates of 25, 40, and 100 Gb/s, the number of independent channels was increased to 10, 16, and 40 respectively. The channel spacing was set to 1.5 GHz, like in the optimized 4 channel scenario. The accumulated bandwidth of all channels was therefore 15, 24, and 60 GHz. The transmission of several of these channels in a real world scenario could e.g. relate to multiple input signals of a MIMO based transmission link.

In Fig. 6 the performance of each channel in the 25 Gb/s scenario is shown. It can be observed that up to 16 km all channels are below the 3GPP limit and that above 16 km severe degradations occur, starting with the channels at higher frequencies. As opposed to pure single carrier systems, the subcarrier-based analog MFH can adapt to the fading spectrum caused by CD, though: for transmission distances up to 80 km, no more than 3 channels are above the 3GPP limit at any point, so that transmission is still possible on the remaining ones.

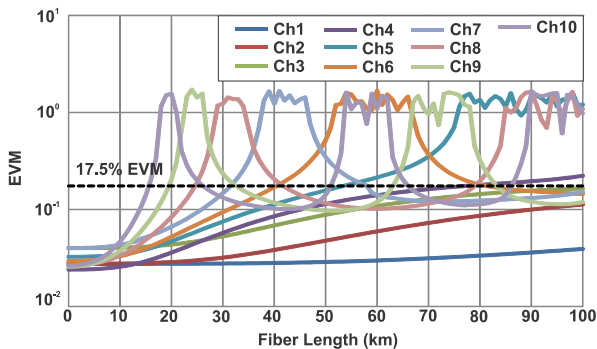

Fig. 6. EVM of 10 analog channels over fiber length for the analog IFoF frontend.

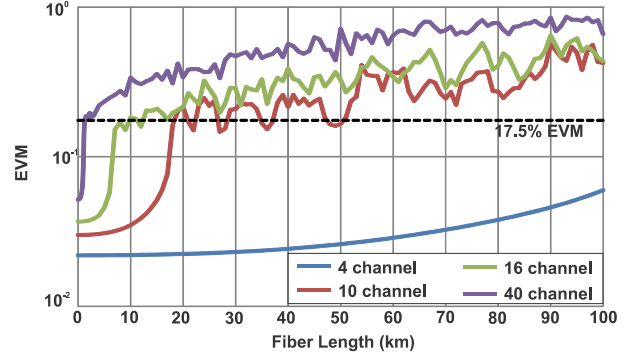

Fig. 7. Average EVM of the 4, 10, 16 and 40 analog channel scenarios over fiber length for the analog IFoF frontend.

Fig. 7 summarizes the performance for all data rate scenarios, i.e. 4, 10, 16, and 40 channels with 10, 25, 40, and 100 Gb/s respectively. The following can be observed: For 10 Gb/s the average EVM stays below the 3GPP limit of 17.5% for all distances; for 25 Gb/s up to 17 km, for 40 Gb/s up to 6 km, and for 100 Gb/s only up to 2 km. As expected, the CD prevents longer transmission distances at higher data rates.

IV. NEXT-GENERATION DIGITAL FRONTHAUL

Next-generation digital fronthaul aims to reduce data rate on the fronthaul by shifting part of the baseband signal processing to the RRH. Different split points are possible [4, 10-12, 20], where a tradeoff between data rate reduction and support for centralized functionalities must be made.

In our system, and in order to significantly reduce the data rate and exploit statistical multiplexing gains, the split is set right after the FEC encoder in the downlink as shown in Fig. 8. Additionally, this split allows a centralized MAC for coordinated scheduling and reduces the impact of m-MIMO on the fronthaul, because the multiple antenna streams partly carry the same data. Thus, shifting the beamforming to the RRH becomes possible. This is a large advantage over fronthaul implementations based on the transport of baseband signals, where fronthaul traffic, or bandwidth respectively, increases linearly with the number of antennas.

A. Simulation Setup

The simulation setup for the Ethernet-based digital fronthaul in the scenario with 10 Gb/s data rate and 4 radio channels is shown in Fig. 8. A random data generator generates the data streams for the four channels separately. Again, a single radio frame containing 63 FEC blocks was generated for each channel and FEC encoded at the BBU. The encoded bit-streams were aggregated and modulated using On-Off-Keying (OOK) without any pulse shaping.

The optical link was the same as described in section III for the analog IFoF system. At the receiver, after low-pass filtering and down-sampling, a simple hard decision of the received OOK symbols was applied. Then the resulting bit-stream was split up into the four channels.

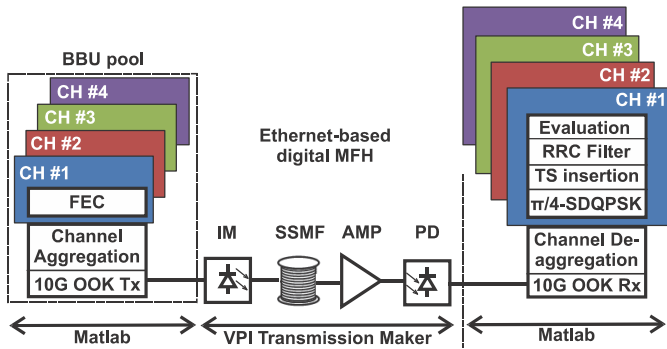

Fig. 8. Simulation setup for digital fronthaul over Ethernet in case of 4 analog channels.

To evaluate the impact of the fronthaul transmission on the $\pi/4$ -SDQPSK signals, the remaining signal processing for the transmitter was applied, namely $\pi/4$ -SDQPSK modulation, training sequence insertion, and pulse shaping. The baseband signals were then directly fed into the evaluation block for EVM calculation. Please note that the EVM degradation in the aggregated digital link, through an increased bit error rate, causes a comparable EVM degradation on the radio channels, which is equal over all channels. For the evaluation of the higher data rate scenarios, the same simulations were performed with a higher number of analog channels.

B. Simulation Results

Fig. 9 shows the average EVM over all radio channels for different fiber lengths and the four data rate scenarios. The following can be observed: For 10 Gb/s the EVM values stay closely below the 3GPP limit up to 100 km; for 25 Gb/s up to 16 km, for 40 Gb/s up to 6 km, and for 100 Gb/s only up to 2 km. However, the EVMs are already close to the 3GPP EVM limit at much smaller distances, indicating very little tolerance for further impairments. This behavior can be attributed to the periodic CD induced power fading.

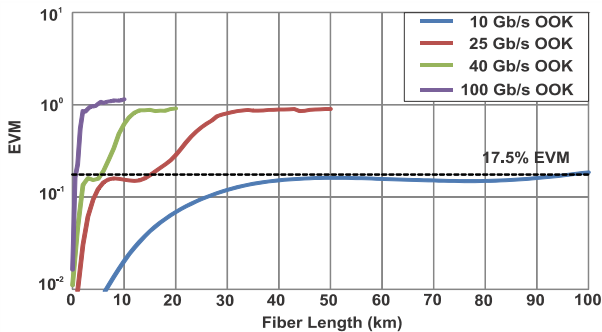

Fig. 9. Average EVM of N analog channels for the 10, 25, 40 and 100 Gb/s data rate scenario, after transmitting over the next-generation digital fronthaul (OOK, NRZ) at different fiber lengths.

V. COMPARISON

Before both novel MFH methods are compared, the performance of a CPRI based link with digitized samples is shown. In the 10 Gb/s system the digitized samples on the fronthaul require a data rate of 200 Gb/s, if a resolution of 10 bit per sample is assumed. The resulting bit stream is

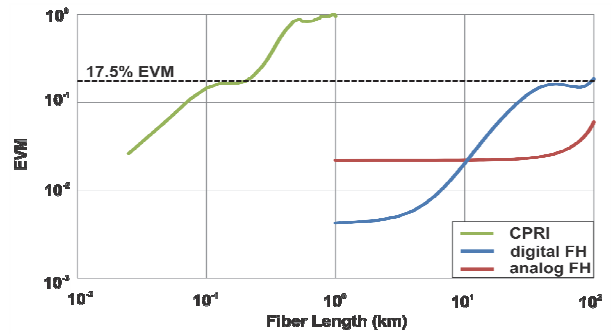

Fig. 10. Average error vector magnitude for CPRI MFH, analog IFoF MFH and next-generation digital fronthaul.

modulated using OOK and transmitted over an optical link as described in section III. Then the received digitized samples are used to restore the 4 radio channels, which are afterwards evaluated by means of the EVM. Fig. 10 shows the performance for the novel MFH approaches and the CPRI based approach for a 10 Gb/s link. For CPRI the maximum link length is only 300 m compared to 95 km for the next generation digital MFH concept and above 100 km for the analog IFoF concept. The better performance of the digital fronthaul at lower distances compared to the analog fronthaul can be explained by the more resilient modulation format. At distances beyond 10 km the higher bandwidth of the digital signals suffers more due to CD. The penalties introduced by CD for the 10 Gb/s scenario are very low over typical fronthaul distances to up to 20-40 km. Even for typical metro distances up to 100 km an acceptable performance is achieved.

For the higher data rates scenarios of 25, 40, and 100 Gb/s, the achievable transmission distances of the analog and the digital fronthaul are nearly the same (see Fig. 7 and 9). Both MFH concepts are limited by the influence of the chromatic dispersion and are not suitable for longer transmission distances.

An experimental assessment of the system at 10 Gb/s simulated here can be found in [21]. While the tendencies shown above are generally confirmed there, the influence of additional noise increases the EVM significantly and the impact of chromatic dispersion appears larger than predicted, restricting the length of the fronthaul to less than 50 km for both fronthaul solutions.

Regarding the integration of the fronthaul into radio systems, the next-generation digital fronthaul approach increases the flexibility of the overall system. It enables statistical multiplexing gains due to the modified functional split, the definition of different kind of flows that can be treated differently in order to guarantee different service level agreements (SLA), or the use of inherent operation, administration, and management (OAM) functionalities. This flexibility becomes mandatory in a heterogeneous 5G network deployment where different kind of traffics (e.g. legacy RAN, control, or synchronization traffic) with different requirements will share the same infrastructure. One drawback of Ethernet is that it does not inherently support any kind of synchronization. In 5G, frequency and time synchronization become critical, especially if coordinated techniques are implemented where a

tight synchronization between cooperative units is required [22]. Nevertheless, different approaches have been proposed to achieve the expected performance, including the implementation of synchronous Ethernet (SyncE), precision time protocol (PTP), time sensitive networking (TSN), or a combination of these [4].

The analog IFoF is the more spectrally efficient solution, but at the price of higher cost for the analog implementation. Furthermore, the complete centralization of the digital signal processing at the BBU site supports the implementation of coordinated techniques while in the digital approach the centralization grade is dependent on the functional split point. At the same time, this centralization results in constant data rates in the fronthaul, so that no statistical multiplexing gains can be realized. This is probably the major drawback of the analog solution. Additionally, convergence with fixed networks or other services, such as backhaul, becomes challenging.

Both technologies will likely coexist in future mobile networks to satisfy different requirements: the next-generation Ethernet-based fronthaul is best suited for large multi-tenant C-RANs using public network infrastructure, where high flexibility is required to share the network among multiple operators with multi-vendor equipment and different kinds of traffic. The analog approach is the best solution for small private C-RANs where the network completely belongs to one operator, such as indoor access networks. Even a combination of both systems in the same C-RAN [20] can be interesting.

VI. CONCLUSIONS

Current mobile fronthaul protocols become impractical to meet 5G data rate requirements. We have investigated two promising approaches to reduce the required optical bandwidth in mobile fronthaul for mm-wave systems, namely an analog IFoF and an Ethernet-based digital fronthaul. Simulations at a data rate of 10 Gb/s have shown that both solutions achieve an EVM below the 3GPP LTE threshold over typical fronthaul distances up to 20-40 km, while requiring significantly less optical bandwidth than current MFH. For higher data rates the investigated concepts are limited to distances of a few kilometers by chromatic dispersion.

ACKNOWLEDGMENT

This work has been funded by the European Union's Horizon 2020 project iCIRRUS (grant no. 644526).

REFERENCES

- [1] China Mobile Research Institute, "C-RAN: The road towards green RAN," whitepaper v.2.6 September 2013.
- [2] Next Generation Mobile Networks Alliance, "NGMN 5G White Paper," 2015.
- [3] V. Jungnickel, K. Manolakis, M. Lossow, W. Zirwas, B. Panzner, M. Sternad, R. Appelfroid, T. Svensson, The Role of Small Cells, Coordinated Multi-point and Massive MIMO in 5G, IEEE Communications Magazine, Special Issue on 5G Wireless Communications Systems: Prospects and Challenges, May 2014, IEEE 52 (5), pp. 44-51.
- [4] P. Turnbull, H. Thomas, D. Venmani, P. Chanclou, V. Jungnickel, L. Fernandez del Rosal, M. Parker, P. Assimakopoulos, K. Kenan

- Al-Hares and N. Gomes, "D3.1 iCIRRUS - Verification of Ethernet as transport protocol for fronthaul / midhaul," 2015.
- [5] S. H. Klim, H. S. Chung and S. M. Klim, "Experimental Demonstration of CPRI Data Compression based on Partial Bit Sampling for Mobile Front-Haul Link in C-RAN," Optical Fiber Communications Conference and Exhibition (OFC), 2016
- [6] J. Zhang, J. Wang, M. Xu, F. Lu, L. Chen, J. Yu and G-K. Chang, "Memory-Polynomial Digital Pre-distortion for Linearity Improvement of Directly-Modulated Multi-IF-over-Fiber," Optical Fiber Communications Conference and Exhibition (OFC), 2016.
- [7] X. Liu, H. Zeng, N. Chand and F. Effenberger, "Experimental Demonstration of High-Throughput Low-Latency Mobile Fronthaul Supporting 48 20-MHz LTE Signals with 59-Gb/s CPRI-Equivalent Rate and 2- μ s Processing Latency," European Conference on Optical Communications (ECOC), 2015.
- [8] C. Ye, K. Zhang, Q. Chang, Z. Gao, X. Hu, X. Huang and X. Sun, "A DSP-Assisted Symbol-Cascade Mobile Fronthaul Solution with Large Capacity and Neat RRs," European Conference on Optical Communications (ECOC), 2015.
- [9] X. Hu, C. Ye and K. Zhang, "Converged Mobile Fronthaul and Passive Optical Network Based on Hybrid Analog-Digital Transmission Scheme," Optical Fiber Communications Conference and Exhibition (OFC), 2016.
- [10] U. Dötsch, M. Doll, H. P. Mayer, F. Schaich, J. Segel and P. Sehier, "Quantitative Analysis of Split Base Station Processing and Determination of Advantageous Architectures for LTE," Bell Labs Technical Journal, 2013, Vol.: 18, Issue:1, pp.:105-128.
- [11] China Mobile Research Institute, "White Paper of Next Generation Fronthaul Interface," Version 1.0 October 4, 2015.
- [12] A. Maeder, M. Lalam, A. D. Domenico, E. Pateromichelakis, D. Wübben, J. Bartelt, R. Fritzsche and P. Rost, "Towards a flexible functional split for cloud-RAN networks," in European Conference on Networks and Communications (EuCNC), 2014
- [13] N. J. Gomes, V. Jungnickel, P. Chanclou, J.-P. Elbers, P. Turnbull, A Flexible, Ethernet Fronthaul for 5th Generation Mobile and Beyond, Optical Fiber Communication Conference (OFC), (invited), W3C.1, 20-24 March 2016, Anaheim, CA.
- [14] N. J. Gomes, P. Chanclou, P. Turnbull, A. Magee, V. Jungnickel, Fronthaul evolution: From CPRI to Ethernet, Journal of Optical Fiber Technology, Elsevier, Vol. 26, Part A, Dec 2015, pp. 50-58.
- [15] K. Habel, L. Fernandez del Rosal, S. Weide, J. Hilt, V. Jungnickel, R. Eschner, C. Schubert, F. Frey, J.K. Fischer and R. Freund, "5 Gbit/s Real-Time Processing Using $\pi/4$ -shift DQPSK for Bidirectional Radio-Over-Fiber System," Tu.D2.3, ICTON 2015.
- [16] L. Fernandez del Rosal, K. Habel, S. Weide, P. Wilke Berenguer, V. Jungnickel, P. Farkas and R. Freund, "Multi-Gigabit Real-Time Signal Processing for Future Converged Networks," 10. ITG-Fachkonferenz Breitbandversorgung in Deutschland, 2016.
- [17] V. Jungnickel and L. Grobe, "Localized SC-FDMA with constant envelope," in Proc. IEEE 24th Int. Symposium on Personal Indoor and Mobile Radio Communications (PIMRC), pp. 24-29, 2013.
- [18] U. Gliese, S. Nørskov, and T. N. Nielsen. 'Chromatic Dispersion in Fiber-Optic Microwave and Millimeter-Wave Links'. In: IEEE Transactions on Microwave Theory and Techniques 44.10 (1996), pp. 1716-1724.
- [19] ETSI Technical Specification 136 104 v12.6.0 (2015-05).
- [20] N. J. Gomes, P. Assimakopoulos, M. K. Al-Hares, U. Habib, and S. Noor, "The New Flexible Mobile Fronthaul: Digital or Analog, or Both?," International Conference on Transparent Optical Networks (ICTON), 2016.
- [21] M. Hinrichs, L. Fernandez del Rosal, C. Kottke, V. Jungnickel, and R. Freund, "Experimental Investigation of New Fronthaul Concepts for 5G," 11. ITG-Fachkonferenz Breitbandversorgung in Deutschland, 2017.
- [22] K. Manolakis, C. Oberli, V. Jungnickel, F. Rosas, "Analysis of Synchronization Impairments for Cooperative Base Stations Using OFDM," Hindawi International Journal for Antennas and Propagation, Vol. 2015, Article ID 125653