

ERFS: Enhanced RSSI value Filtering Schema for Localization in Wireless Sensor Networks

Seung-chan Shin and Byung-rak Son and Won-geun Kim and Jung-gyu Kim

Department of Information Communication Engineering, Daegu University, Republic of Korea
{ scshin,brson,wgkim,jgkim }@daegu.ac.kr

Abstract. In this research, we have suggested the Localization Algorithm using Probable Filtering Schema of RSSI without additional hardwares. The existing method has been filtering with only average and feedback of received RSSI values. This method was not considering about the variation of RSSI when obstacles are moving at indoor environment. In this research, we have suggested the probable filtering algorithm which is considered factors of errors at indoor environment and we have demonstrated the superiority of this algorithm through the examination. It presents 14.66% and 11.65% improved accuracy than the existing filtering algorithm.

1 Introduction

The localization technology is one of the key technologies to realize invisible technology in the ubiquitous society. It is possible to make an active computing environment by automatic sensing. It is also possible to give users the useful information naturally without any recognition. Therefore, there are many localization technologies which has been studying with various communication method.

Especially, LBS(Location Based Service), which used GPS(Global Positioning System) with the auto navigation system and mobile network based, is already used in various fields and it has been developing indispensably[1].

Sensor network, one of the key technologies on ubiquitous computing, has been studied with the development of ubiquitous computing technologies. The node localization system has been particularly studied in various application fields for developing technology and reducing errors of measurement. The applications which are based on the local information of nodes are Home Automation, Preventing missing child system, Preventing stranger system, Chasing the location of patient and doctor at the hospital, Analysis of consumer preference at big market or department store, Preventing disaster system and so on[4][5][6][7][8].

Generally, indoor localization system uses the RSSI(Received Signal Strength Indication) with ZigBee protocol in wireless sensor network. Because there are some advantages. It is possible to localize without additional hardwares. It is cheaper for setting system, and it has wide application range. However, there are also some disadvantages on RF such as diffraction, reflection, multi-path, and so on.

The localization system with RSSI could measure almost accuracy at indoor environment where could get LoS(Line of Sight), while the RSSI values are not correct at Non-LoS environment because of obstacles.

In this research, we have suggested the RSSI filtering algorithm to reduce errors when we localize at indoor environment and another filtering algorithm to accurately localize without additional hardwares. We have been struggling to reduce errors of RSSI at indoor environment because of obstacles by using those filtering algorithms.

2 Related research

2.1 General process of localization

There are five steps on processing of localization. Those are collecting of the location information, converting of the location information, filtering, calculating of the location value, and smoothing. Among these steps, it must involve collecting of the local information, converting of the location information, and calculating of the location value. There are processes about each step[9][10][11][12].

The collecting of the location information is performed between terminal node and beacon node. The local information could be RSSI, ToA(Time of Arrival), or AoA(Angle of Arrival). The variation of the location information is one of processes to use on calculating of the location value. It could be converted using propagation model into distance in terms of location information types. If the location information is RSSI, it can use Friis's propagation model. If it is ToA, it can use the propagation model which is based on physics related with light of propagation.

Filtering is the process which is selecting the changed distance of the location information for location calculating more accurately. There are Cell-ID, ToA, TDoA(Time Difference of Arrival), AoA, and Fingerprint in the method of location calculating. Smoothing is the process which reflects real-time location information, using a location value of nodes which has been received before[2][3].

2.2 Characteristics of RSSI value

Generally, RSSI values are presented as equation 1 at outdoor environment where it is guaranteed LoS. If the equation 1 is presented by graph on ideal environment. It will be same as figure 1[13].

$$RSSI = -(10n \log_{10} d + A) \quad (1)$$

- n : signal propagation constant
- d : distance from receiver
- A : RSSI at indoor environment far from 1m

It presents the RSSI values at outdoor environment in 1m on figure 2. We could recognize that it presents the distribution regularly, and it is distributed by bisymmetry based on -11dBm.

However, there are great differences in received RSSI values at indoor environment because of obstacles. The figure 3 presents the variation of RSSI values at outdoor environment in 1m. We could recognize that the RSSI values are not bisymmetry.

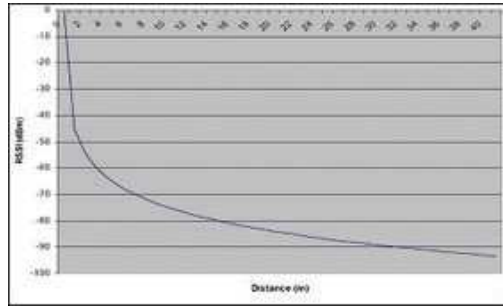

Fig. 1. Ideal RSSI values (on equation 1, $A=40$, $n=3$)

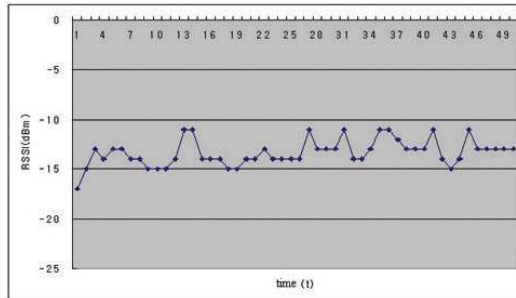

Fig. 2. The variation of RSSI values in terms of received time at outdoor environment in 1m.

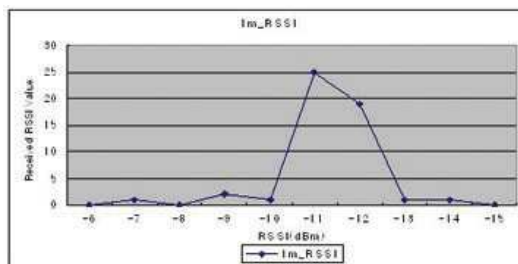

Fig. 3. The frequency of distribution curve of RSSI values at outdoor environment in 1m.

2.3 General filtering method

There are two ways of filtering methods generally which are average and feedback.

The average filtering method is presented as equation (2). It has variable formation that the RSSI value which has been received before is changed by another RSSI value which has been received right after.

$$\overline{RSSI}_n = \frac{1}{n} \sum_{i=0}^n RSSI_i \quad (2)$$

- n : the number of received RSSI value
- $RSSI_n$: the received RSSI value in round n
- $RSSI_i$: the received RSSI value in round i

The feedback filtering method is presented as equation (3). It has the variable formation with the RSSI value which has received before exchanges another RSSI value which received right before.

$$RSSI = a \cdot RSSI_n + (1 - a) \cdot RSSI_{n-1} \quad (3)$$

- $RSSI_{n-1}$: the received RSSI value in round $n-1$
- a : weigh constant ($0 < a < 1$, generally, $a \geq 0.75$)

The average and feedback filtering method could be available at outdoor environment when the LoS is guaranteed but, it has some problem at indoor environment which illustrate lower accuracy because of obstacles environment which illustrate lower accuracy because of obstacles.

3 Suggested filtering method

The RSSI value can not be measured by obstacles accurately at indoor environment. If the RSSI value which has lower accuracy uses in general filtering methods; average or feedback filtering method, it could make big errors. In this research, we have suggested the enhanced probable filtering method to obtain a higher accuracy than average or feedback filtering method.

In figure 4, it illustrates to select the k_{max} among the measured RSSI values on the suggested filtering algorithm. It can be separated into area A and area B. It could be the higher accuracy RSSI value between transmitter node and beacon node in area A. But, it could be received the lower accuracy RSSI value in area B because there is an error by obstacles. The problems could improve the accuracy of RSSI values by removing the error tolerance by obstacles and getting the average.

If there are errors by obstacles at indoor environment as figure 4, the average and feedback filtering algorithm present big difference compared with ideal RSSI values in figure 2. In this research, we have examined to get higher accuracy RSSI values at

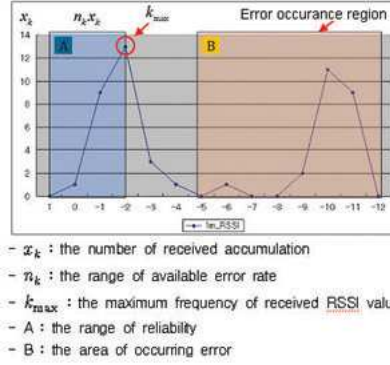

Fig. 4. The variation of RSSI values at indoor environment in 1m; it illustrates the RSSI values with k_{max} of suggested filtering method

indoor environment with previous RSSI value of k_{max} and to remove the scattered form of the area B in an accumulated distribution chart as figure 4.

The processes of execution are the first, to check the frequency table with received RSSI values, second, to figure out the maximum constant, at last, to calculate the average from the maximum constant to the highest k_{max} . It comes under area A in figure 4. The equation 4 illustrated the suggested filtering algorithm. The figure 5 is a flow chart of suggested filtering algorithm.

$$RSSI_k = \frac{\sum_{k=1}^{k_{max}} n_k x_k}{N_{k_{max}}} \quad (4)$$

- x_k : Data(RSSI value)
- n_k : times
- $n_k x_k$: Data * times
- N_k : cumulative times
- k_{max} : maximum times

There is a disadvantage which keeps the frequency table on memory compared with average filtering method but, it does not increase the complexity. The frequency table doesn't matter to operate sensor nodes because it is stored small amount of memory. For example, if a frequency table has 50 RSSI values, it must need only approximately 50bytes.

4 Examination environment and result

4.1 Examination environment

We have examined the environment in corridor as figure 6. We considered some obstacles such as walls and appliances. We set the sensor node on the 1.5m fixed body from

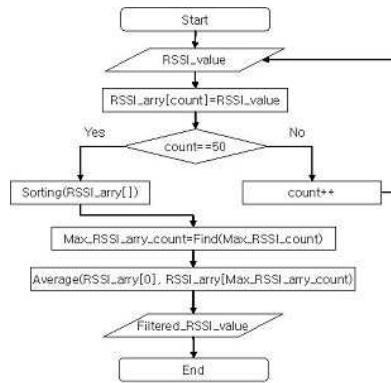

Fig. 5. The flow chart of suggested filtering g algorithm

bottom. We repeated comparing and analyzing the received packets 50 times over 15m because of the available communication range of ZigBee.



Fig. 6. Examination environment

4.2 Hardware and Firmware

We used the Nano-24 made by Octacom. co., ltd. These are sensor nodes which are based on Nano-Q+ and it's developed for education and development kit. MCU is ATmega128L used RISC structure. It supports an interior flash memory based on ISR(In-System Reprogrammable), a 4Kbytes SRAM and a 4Kbytes EEPROM. It also supports an exterior 512Kbytes flash memory and a 32Kbytes SDRAM. Nano-24 is made up of four modules such as Main, Interface, Sensor and Actuator. Figure 7 show structure of main module Among these, we used the main module which involves ATmega128L and CC2420 as figure 8[14][15].

We did firmware porting on sensor nodes which we have developed except OS for sensor node. The figure 8 presents the firmware structure. We optimized that it doesn't

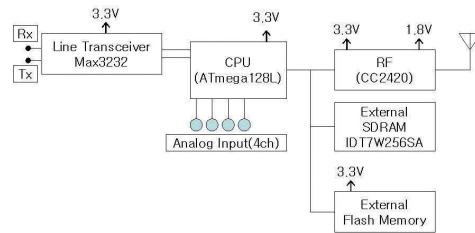

Fig. 7. Structure of main module

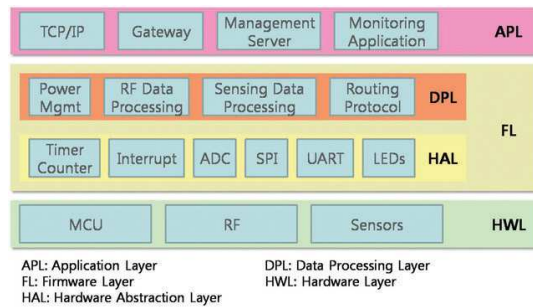

Fig. 8. The structure of Firmware

depend on the OS. We also reduced the MCU resource consumption than TinyOS. For example, we reduced flash memory about two times, SRAM about 1.45 times than CntToLedAndRfm which is a RF LED testing program. We actually could reduce the resource consumption which is a simple RF testing program without data if we regard to CntToLedAndRfm. The efficiency of memory management could realize more flexibly on transport layer and network layer with minimizing hardwares in further future.

4.3 Result of examination

The figure 9-11 present the received RSSI values on each time with suggested algorithm from 1m-15m ideal values as it is farther and farther. It causes by obstacles such as walls and appliances at indoor environment.

The figure 9-11 are the graph which is represented table 1 and 2. It presents the comparing result with three kinds of filtering methods. The distance is a standard with ideal RSSI values and it compares with the error of distance. The negative means that the suggested filtering algorithm has lower accuracy, while the positive means that it has higher accuracy in improving rate. It has similar accuracy with feedback filtering method or more without in 2m. The reason is that it presented big improvement of error rates because the last one has slight different value among received 50 RSSI values in 2m. It is the special case. In other case, it causes big errors than other methods. The algorithm presents the highest accuracy in 4m.

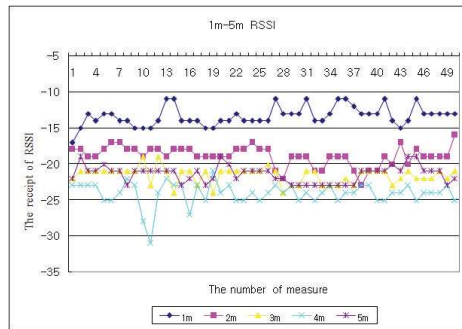

Fig. 9. The variation of RSSI value in 1-5m

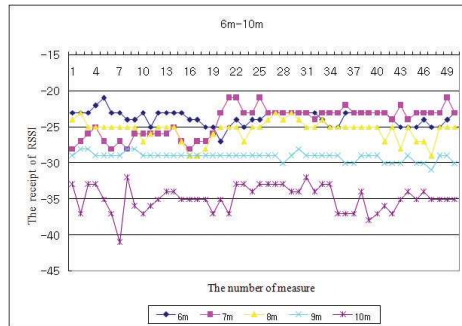

Fig. 10. The variation of RSSI value in 6-10m

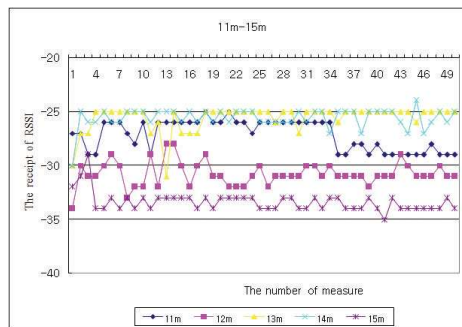

Fig. 11. The variation of RSSI value in 11-15m

Table 1. Comparison of received RSSI value, Ideal, ERFS, Average and Feedback Filtering scheme

Ideal		ERFS	Average Filtering	Feedback Filtering
RSSI	distance	RSSI	RSSI	RSSI
-5.00	1	-13.00	-13.36	-12.99
-11.02	2	-18.35	-18.90	-17.19
-14.54	3	-20.83	-21.58	-21.30
-17.04	4	-22.78	-24.08	-24.36
-18.97	5	-20.63	-21.44	-22.15
-20.56	6	-22.88	-23.72	-24.35
-21.90	7	-22.64	-24.24	-21.80
-23.06	8	-24.70	-25.42	-25.49
-24.08	9	-28.84	-29.14	-29.16
-25.00	10	-33.94	-34.90	-34.95
-25.82	11	-26.34	-27.14	-28.96
-26.58	12	-30.35	-30.78	-30.89
-27.27	13	-25.00	-25.58	-25
-27.92	14	-24.96	-25.60	-25.30
-28.52	15	-33.34	-33.38	-33.75

Table 2. Comparison of conversion distanc, Ideal, ERFS, Average and Feedback Filtering scheme and accuracy comparison of each other

Ideal		ERFS		Average Filtering		Feedback Filtering		Advance	
RSSI	distance	conv. dis	conv. err	conv. dis	conv. err	conv. dis	conv. err	P/A(%)	P/F(%)
-5.00	1	2.51	1.51	2.33	1.61	2.50	1.50	10.62	-0.22
-11.02	2	4.65	2.65	4.41	2.95	4.07	2.07	15.19	-28.95
-14.54	3	6.19	3.19	6.01	3.74	6.53	3.53	18.39	11.30
-17.04	4	7.75	3.75	8.01	4.99	9.29	5.29	31.04	38.51
-18.97	5	6.04	1.04	5.91	1.63	7.13	2.13	11.77	21.63
-20.56	6	7.83	1.83	7.69	2.62	8.45	2.45	13.18	10.29
-21.90	7	7.62	0.62	8.16	2.16	7.51	0.51	21.98	-1.50
-23.06	8	9.66	1.66	9.35	2.49	10.23	2.23	10.39	7.11
-24.08	9	15.99	6.99	14.35	7.06	17.17	8.17	0.78	13.11
-25.00	10	27.99	17.99	27.86	21.26	31.56	21.56	32.61	35.63
-25.82	11	11.67	0.67	12.79	1.79	15.77	4.77	10.19	37.33
-26.58	12	18.53	6.53	19.45	7.45	19.72	7.72	7.67	9.91
-27.27	13	10.00	3.00	10.69	2.30	10	2.99	-5.31	-0.05
-27.92	14	9.95	4.04	10.71	3.28	10.36	3.63	-5.41	-2.88
-28.52	15	26.14	11.14	26.24	11.24	27.41	12.41	0.66	8.48
P:ERFS / A:average filtering / F:Feedback filtering / conv.:conversion							average adv	11.58	10.65

It is the graph which compares with filtered RSSI values. We could recognize that the suggested algorithm is closer to the ideal RSSI value than average and feedback filtering method.

In the figure 12, 13, when the algorithm is applied to the ideal RSSI value and distance, we could find out improved accuracy because there are few conversion distance errors than average and feedback filtering method.

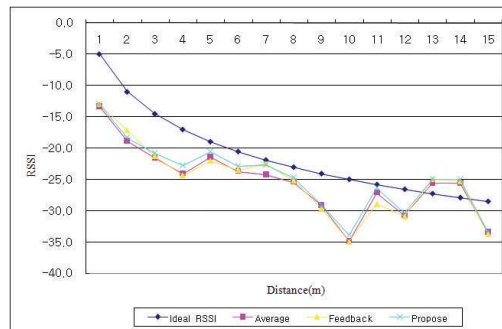

Fig. 12. Comparing the suggested RSSI value

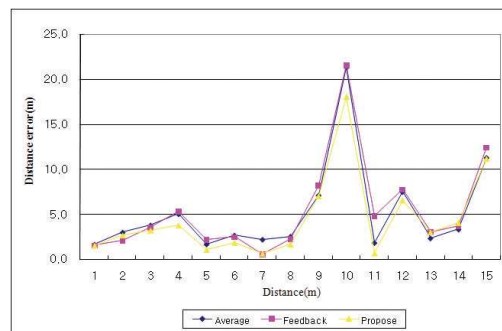

Fig. 13. Comparing distance error with converted RSSI

Lastly, when it compares with the average filtering method, it presents 32.16% improved accuracy in 10m. It also presents 38.51% improved accuracy in 4m when it compares with the feedback filtering method. It has 11.58% and 10.65% average improvement on each average and feedback filtering method.

5 Conclusion

In this research, we have suggested RSSI filtering algorithm without additional hardwares. It improved an accuracy in distance estimation compared with existing average and feedback filtering algorithm on the distance estimation system. Especially, we have examined for the improvement of localization accuracy at indoor environment. It is simple so we could improve the localization accuracy on micromini sensor with low electronic power without additional calculation and complexity. We have demonstrated how much it has been improved. We recognized that the result had improved the 11.58% accuracy than average filtering method, 10.64% accuracy than feedback filtering method. However, we didn't consider about moving nodes. In addition, there is a disadvantage increasing the packet between nodes for distance estimation. After this time, we could study to improve the distance estimation accuracy, considering moving nodes and minimized increasing rate of packets.

Acknowledgement: This research was financially supported by the Ministry of Commerce, Industry and Energy (MOCIE) and Korea Industrial Technology Foundation (KOTEF) through the Human Resource Training Project for Regional Innovation and in part by MIC & IITA (07-Infrastructure-10, Ubiquitous Technology Research Center).

References

1. Lee, Yang, Lee, Cha.: Localization Technology in Ubiquitous Environment. Korean Society for Internet Information, Vol 7. No 2, pp.30–37 (2006)
2. Hakyoung Kim: Location Information Service based Wireless Lan. Telecommunications Review, Vol 16, pp.188–202, (2006)
3. P. Bahl, V.N. Padmanabhan.: RADAR : An In Building RF-Based User Location and Tracking System. In Proceeding of IEEE infocom 2000 Conference on Computer Communication, Vol.2, pp.775–784 (2000)
4. Ekahau, Inc., <http://www.ekahau.com>
5. Place Lab at Intel Corporation, <http://www.placelab.org>
6. R. Want, A. Hopper, V. Falcao, and J. Gibbons.: The Active Badge Location System. ACM Trans. on Information Systems, Vol.10, pp.91–102 (1992)
7. N. Priyantha, A. Chakraborty, and H. Balakrishnan: The Cricket Location-Support System. Proc. of the ACM Int'l Conf. on MobiCom, (2000)
8. J. Hightower, R. Wand, and G. Borriello: Spoton: An Indoor 3d Location Sensing Technology Based on RF Signal Strength. Technical Report 00-02-02. University of Washington (2000)
9. SpotON: Ad-hoc Location Sensing, <http://portolano.cs.washington.edu/projects/spoton>
10. Portolano: An Expedition into Invisible Computing, <http://portolano.cs.washington.edu>
11. Hakyoung Kim, Sungduk Kim, Donggil Sue, Jungkang Ji, Hyuntae Jang: A close distance localization Technology tendency. IITA weekly technology tendency, No. 1322, pp.1–12 (2007)
12. Wonhee Lee, Wooyoung Lee, Minkyu Kim, Duseup Eum, Jinwon Kim: Location Measurement System Technology tendency for Ubiquitous Environment. The Korean Institute of Information Scientists and Engineers, Vol 22. No 12, pp.41–50 (2004)

13. K. Aamodt: CC2431 Location Engine. Applications Note AN042. Texas Instrument Incorporated (2006)
14. Octacomm Inc.: <http://www.octacomm.net>
15. Octacomm Inc.: Understanding of Embedded System, (2006)